

**Important!** This quick reference guide does not replace the user manual which can be downloaded at [www.humancaregroup.com](http://www.humancaregroup.com).  
**Read all instructions before use!**

### Components

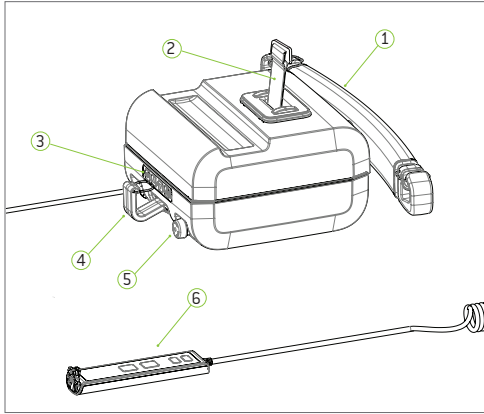





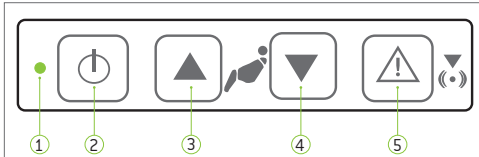



- 1 Telescopic Hanger Bar
- 2 Lift Belt
- 3 Secondary Panel
- 4 Leg Hook
- 5 Emergency Stop
- 6 Hand Control

### Secondary Panel Functions



- 1 Status Indicator Light
- 2 Power On/Off
- 3 Raise Lift
- 4 Lower Lift
- 5 Emergency Lowering

### Status Indicator Lights

-  **Flashing Green**  
On/Ready for Use  
Full Battery
-  **Flashing Yellow**  
On/Ready for Use  
Charge Battery Warning
-  **Flashing Red**  
On/Ready for Use  
Low Battery
-  **Constant Green**  
Lift in Use  
Lift Loaded
-  **Constant Red**  
Safety Catch Engaged  
Troubleshooting!
-  **Constant Yellow**  
Lift Charging  
Functions Blocked
-  **Flashing Green/Yellow**  
Service Warning  
Perform Inspection
-  **Flashing Red/Yellow**  
Service Passed  
Battery Low

**Important!** This overhead lift has been designed and tested for indoor use with one patient at a time. This product must not be immersed in water.  
**Read all instructions for full product information!**

### Hand Control Functions

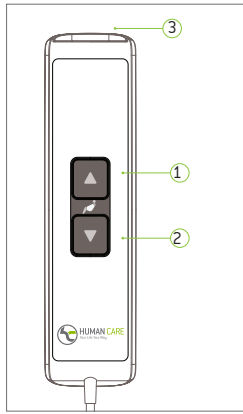

- 1 Up Button
- 2 Down Button
- 3 USB and Charge Port





**Important!**

The covers for the USB input and the charging input [3] must be closed for the hand control's water protection (IPX5) to be valid.

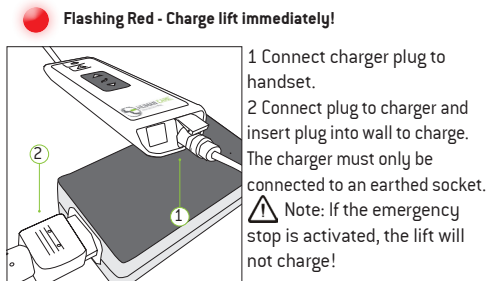
### Charging the Lift



-  **Flashing Red - Charge lift immediately!**
- 1 Connect charger plug to handset.
- 2 Connect plug to charger and insert plug into wall to charge. The charger must only be connected to an earthed socket.
-  **Note:** If the emergency stop is activated, the lift will not charge!

**Important!** The lift can only be used with a Human Care charger and must be disconnected to use the lift.

Models: 55030, 55040, 55050  
Human Care HC AB. All Rights Reserved.



### Using the lift

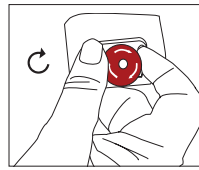

**Emergency Stop Activation**  
Press down on red button to activate.

**Emergency De-Activation**  
Turn red button clockwise.

**Important!** Emergency lowering must only be used in emergency situations. There will be a 3 second delay.



To activate, press handset "Down" button (2) and secondary panel emergency lowering button (5) at the same time.

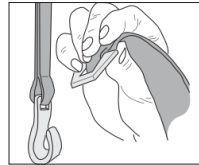

### Suspending the lift

Place the lift on a suitable surface and feed out belt by gently pulling out belt while at the same time pressing the "Down" button on either the hand control or secondary panel. Hook lift

belt onto distance strap so that it is held firmly in position (easiest to hook from above at an angle as shown). **Ensure the lift belt is firmly in place before use.**

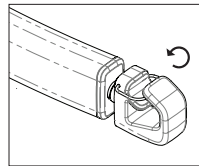

### Telescopic hanger bar

Three adjustable positions (40, 50 and 60cm) - turn hook counter-clockwise while gently pulling out. Hook will fall into each position. Repeat until desired distance is achieved.



### Slings

Attach head sling loops to carry bar first, then leg straps to leg hooks. Ensure the straps are secured beneath the safety pin.





### Proper lifting techniques

Do not use the telescoping bar to move the patient and the lift. Do not hold onto the hooks while performing a lift. Once the patient is comfortably secured in sling, raise lift, hold sling and position/move patient.

### General Care

 Charge lift every night.

 Wipe down with slightly dampened drying cloth.

 Disinfect with DuPont™ Virkon®.

 Never use strong detergents on lift.

 Do not immerse in water.







 Activate emergency stop when not in use.

 **Important! Do not use strap to transport!**  
Lift must always be stored or moved in horizontal position. Rest on cart to move.

### Inspection

**Annual Inspection** - The lift must be inspected at least once per year by a qualified technician certified by Human Care.  
**Monthly Inspection** - Check lift belts for damage or wear. Feed entire length to ensure proper functioning.  
**Daily Inspection** - Always inspect the lift for visible signs of damage before use. Ensure the lift is correctly mounted on the distance strap or rail roller. Always check slings and belts for signs of wear before use. Do not use if wear evident.

### Troubleshooting

-  **If the indicator light is not on, check the following:**
  - Mains switch is on
  - Batteries do not require charging
  - Emergency stop button is not pushed in (deactivate by turning clockwise)
-  **If the indicator light is flashing, check the following:**
  - Check the hand control button functions up / down when depressed (replace if necessary)
  - When pressing up, the lift is not already in its maximum upper position
  - When pressing down, the lift is not already in its maximum lower position
-  **If the indicator light is constant red:**
  - The lift motor is overheated - allow to cool
  - The lift is overloaded - lower using emergency lowering button
-  **If the indicator light is constant yellow:**
  - Charging in progress
-  **If the lift belt does not feed out properly:**
  - Pull the belt upwards at the same time as you depress the Down button on the hand control / lift panel
-  **If the indicator changes to flashing red:**
  - The batteries need charging, patient may be lifted a few more times