

VERO CARE CLINER

OWNERS OPERATING AND MAINTENANCE MANUAL



**IMPORTANT - DO NOT DISCARD THIS MANUAL.
KEEP THIS MANUAL FOR FUTURE REFERENCE AND TRAINING.**

Copyright © 2021 Winco Mfg., LLC

READ AND FAMILIARIZE YOURSELF WITH ALL INSTRUCTIONS BEFORE USING THIS PRODUCT.

Do NOT install, maintain, or operate this equipment without reading and following this manual, otherwise injury and/or damage may result.

IF YOU HAVE ANY QUESTIONS OR CONCERNS,
PLEASE CONTACT WINCO MFG., LLC.

Winco assumes no responsibility for damage or injury caused by improper assembly, installation, use, or maintenance of these products.





No part of this manual may be duplicated in any form without the prior consent of Winco Mfg., LLC. Unauthorized duplication and/or distribution of these materials may result in civil prosecution to the maximum extent allowed by law.





The information contained in this manual is subject to change without notice.

SAVE THESE INSTRUCTIONS FOR FUTURE REFERENCE.

These instructions are available online.
Visit wincomfg.com to download.

PRODUCTS WITH THE FOLLOWING MARKINGS ARE INTENDED FOR COMMERCIAL USE ONLY:

 C US	 	100-240 VAC 44W, 50-60Hz Supply: 12V  Operating Conditions: 10° - 40° C	WARNING: Long-term, continuous exposure to heat may cause burns. Read instructions before using. DO NOT use wet. DO NOT insert pins into upholstery.
---	--	---	---

 C US 007675 REV A	 	100-240VAC, 50-60Hz, 130W Battery Input/Output: 30V/24V  Operating Conditions: 10° - 40° C WARNING: Long-term continuous exposure to heat may cause burns. Read instructions before using. DO NOT use wet. DO NOT INSERT pins into upholstery.
---	--	--

SYMBOLS



FOLLOW INSTRUCTIONS



DC VOLTAGE



SYMBOL FOR MANUFACTURER



TYPE B APPLIED PART



PINCH-POINT WARNING



GENERAL WARNING



TRENDELENBURG

TABLE OF CONTENTS

INTENDED USE STATEMENT.....	5
TRANSPORTATION, STORAGE, HANDLING & DISPOSAL.....	5
PREPARATION: BEFORE YOU BEGIN.....	5
IMPORTANT SAFETY INFORMATION.....	6
FOR CHAIRS WITH POWERED OPTIONS (POWERED RECLINER WITH HEAT AND MASSAGE, ETC.).....	7
ISOLATION DIAGRAM FOR HEAT & MASSAGE OPTION.....	8
SCHEMATIC DIAGRAM FOR POWER RECLINER OPTION.....	9
FOR ALL CONFIGURATIONS (HEAT AND MASSAGE, ETC.).....	10
ASSEMBLY INSTRUCTIONS.....	11
BACK ASSEMBLY.....	11
ARMREST COVER INSTALLATION (OPTIONAL ACCESSORY).....	13
OPERATING INSTRUCTIONS: ATTENDANT.....	15
CASTER OPERATION: LOCK / UNLOCK.....	15
FOOT PLATE OPERATION (OPTIONAL FEATURE).....	16
RECLINE CHAIR (ATTENDANT POSITION).....	17
RECLINING CHAIR (ATTENDANT POSITION, POWER RECLINER).....	18
RETURN CHAIR TO UPRIGHT POSITION (ATTENDANT POSITION).....	19
RETURN CHAIR TO UPRIGHT POSITION (ATTENDANT POSITION, POWER RECLINER).....	20
ACTIVATING TRENDELENBURG POSITION (ATTENDANT ONLY).....	21
TRENDELENBURG TO RECLINE (ATTENDANT ONLY).....	21
ACTIVATING TRENDELENBURG POSITION (ATTENDANT ONLY, POWER RECLINER).....	22
SWING-ARM OPERATION (ATTENDANT ONLY).....	23
TRANSFERRING PATIENT TO CHAIR (SWING-ARM ONLY).....	24
SIDE TABLE OPERATION (OPTIONAL FEATURE).....	25
PIVOT TABLE OPERATION (OPTIONAL FEATURE).....	26
OPERATING INSTRUCTIONS: OCCUPANT.....	27
RECLINE WHILE IN THE SEATED POSITION (POWER RECLINER MODELS ONLY).....	28
RETURNING TO SEATED POSITION (NON-POWER RECLINER MODELS ONLY).....	29
RETURNING TO SEATED POSITION (POWER RECLINER MODELS ONLY).....	30
HEAT / HEAT & MASSAGE OPERATION (OPTIONAL FEATURE).....	31
GENERAL MAINTENANCE.....	33
GAS CYLINDER OPERATION.....	33
GENERAL CARE & CLEANING.....	34
OPTIONAL BATTERY.....	35
SPECIFICATIONS (NON-POWER MODELS).....	36
SPECIFICATIONS (POWER RECLINER MODELS).....	37
VERO CARE CLINER OPTIONS.....	38
WARRANTY INFORMATION.....	39

INTENDED USE STATEMENT

The Verō Care Cliner is a recliner for use in medical settings. It is designed to provide comfort for patients seated for extended periods of time while receiving clinical treatments such as Dialysis or Infusion or during recovery from surgical procedures where positional adjustments are beneficial. The recliner is also suitable for general use in many medical settings such as, but not limited to, hospital room chair, waiting room chair, convalescent home chair, etc.

TRANSPORTATION, STORAGE, HANDLING AND DISPOSAL

- The product should be transported in factory packaging, inside an appropriate medium for the destination, i.e. truck, air, or sea cargo containers.
- The product should be stored in a dry environment that will inhibit rust or mold formation.
- Winco Mfg., LLC recommends not leaving the product in the factory packaging in excess of three (3) months.
- The product should always be handled in a manner consistent with the user instructions and in a manner to prevent contamination after each use.
- The product has many recyclable components and to the extent practical, all effort should be used to recycle responsibly. Otherwise, the product components shall be disposed of in accordance with local statutes.

PREPARATION: BEFORE YOU BEGIN

1. You should thoroughly read and possess a full understanding of this manual before using this product. It is imperative that all users know how to properly operate all functions and features of this product, including, but not limited to, footplate, casters, swing arms and side table operation and any accessories including Heat, Heat & Massage, and Power Recline.
2. Carefully examine your product for any damage. Be sure to inspect all components. **IF DAMAGE IS EVIDENT, CONTACT FREIGHT CARRIER OR WINCO IMMEDIATELY.**
3. Remove all packaging material and any hardware that was secured for shipping. Save packaging (see #6 below)
4. Carefully remove all components and any included tools and/or parts from the carton.
5. You may need to cut packaging materials with a box cutter or scissors to access the product. Use **CAUTION** to avoid personal injury or damage to the product.
6. Save all boxes and packaging material until **AFTER** you have assembled your product and have verified that all components are functioning properly. These material are required if it becomes necessary to return the product.
7. Read all hangtags and labels carefully. Hangtags and labels contain pertinent information regarding your product specifically. They may be located on the back of the chair, attached to the handles or chair back.
8. **DO NOT** install, maintain, or operate this equipment without reading and following this manual otherwise injury and/or damage may result. In the event that someone improperly operates this product and causes damage to it, the warranty may be voided. **IF YOU HAVE QUESTIONS OR CONCERNS PLEASE CONTACT WINCO MFG., LLC.**

WINCO ASSUMES NO RESPONSIBILITY FOR DAMAGE OR INJURY CAUSED BY IMPROPER ASSEMBLY, INSTALLATION, USE, MODIFICATION, OR IMPROPER MAINTENANCE OF THESE PRODUCTS.

IMPORTANT SAFETY INFORMATION

FOR CHAIRS WITH POWERED OPTIONS (HEAT, MASSAGE, POWER RECLINER, ETC.)

When using an electrical appliance, basic precautions should always be followed, including the following:



To reduce the risk of electric shock always unplug this product from the electrical outlet and disconnect the battery (if equipped) before reaching inside, cleaning, maintenance or servicing. Do not operate the chair unless all four wheels or pedestal feet are resting on the floor.

1. Unplug this product from the electrical outlet when not in use.
2. Supervision should be provided when using this product.
3. Use this product only for its intended use as described in this manual.
4. DO NOT use attachments not recommended by the manufacturer.
5. Never operate this product and remove from service if it has a damaged cord or plug, if it is not working properly, if it has been dropped or damaged, or dropped into water, contact an authorized Winco service center for instructions.
6. DO NOT carry or pull this product by power supply cord or use the cord as a handle.
7. Keep the cord away from heated surfaces.
8. DO NOT use outdoors.
9. To disconnect, position all controls to the "off" position, then remove the plug from the outlet. Pull the molded plug end only to remove the cord; never pull on the cord only.
10. Clean the switch with a damp cloth only. Warranty will be VOID if liquid is introduced into the switch mechanism(s) or any electrical components.
11. Extension cords are not recommended.
12. DO NOT roll recliner or other equipment over the cord and always keep the cord stored properly (see "Cord Storage" on page 32). Proper cord storage is essential in order to prevent damage. Should any cord or any electrical components have any signs of damage, they should be immediately replaced to avoid the possibility of liquid penetration or exposure to current, which can cause further damage to other components, caregivers, or patients.
13. This product is shipped with a 3 pin cord set for North America on a nominal 120 VAC circuit. The product will operate on circuits from 120-240 VAC with a local country power cord equipped with an IEC plug into the controller. If the plug does not fit into the outlet, contact a certified electrician to install the proper outlet. DO NOT MODIFY THE PLUG IN ANY WAY. No adapter should be used with this product.
14. For an added level of safety; Winco recommends the use of a 120 volt GFCI (ground fault circuit interrupter) outlet.
15. Never insert pins or attach other metallic fasteners into or onto any part of this chair.
16. DO NOT use this product if the covering shows signs of deterioration, such as checking, blistering, or cracking.
17. KEEP DRY. DO NOT operate in a wet or moist condition or environment.



Long term, continuous exposure to heat may cause burns. It is recommended that skin in contact with heated area be checked for redness and blistering during long term usage. DO NOT use on an infant or incapacitated person. DO NOT use on insensitve skin or on a person with poor blood circulation. If you are uncertain if you should use this product, please consult your physician about the use of heat and massage.



DO NOT crush or pinch heating elements or wiring.

IMPORTANT SAFETY INFORMATION CONTINUED ON THE NEXT PAGE

IMPORTANT SAFETY INFORMATION (CONTINUED)
FOR CHAIRS WITH POWERED OPTIONS (HEAT, MASSAGE, POWER RECLINER, ETC.)

ADDITIONAL INFORMATION FOR VERO CARE CLINER PRC (POWER RECLINER CHAIR) ONLY:

1. The Vero Care Cliner PRC (Power Recliner Chair) uses a linear actuator to drive the recline mechanism inside the chair. The actuator is controlled with a switch panel on the outside of the right hand arm or optionally both arms. A handset can be ordered for convenience of the attendant.
2. The Handset or switch panel should ONLY be used to position the chair recline angle; unless using the Trendelenburg feature, which may be performed manually. Trendelenburg does not require use of the handset switch panel. The Vero Care Cliner PRC may be positioned from full upright to full recline position using the handset or switch panel.
3. NEVER attempt to close the leg rest manually on a Power Chair. The recline motion is controlled by the handset or switch panel; therefore, forcing the chair into a different recline angle will damage the chair and void the warranty.
4. The Vero Care Cliner PRC includes an "AC to DC" switching power supply, operating from a standard AC power outlet (120 VAC/60 Hertz nominal) and a supplemental rechargeable battery (optional). This power supply allows operation world wide on voltages from 100-240 VAC and frequencies from 50-60 HZ with the proper power cord.
5. The (optional) rechargeable battery is a back up system to be used for power outages. Allowing the battery to diminish lower than 30% (see page 35 "Battery Status Indicator") can cause permanent damage to the battery, resulting in the battery no longer being able to hold a full charge. This will void the warranty on the battery.
6. To fully charge the (optional) rechargeable battery for the first time, the Vero Care Cliner PRC must be plugged in for 10 hours. Uncoil the power cable from the back of the Power Reclining Chair and plug it into a properly grounded outlet. Plugging in the Vero Care Cliner PRC initiates the battery to charge. Please refer to the "Power Requirements" on page 9 for further information.
7. Removal of power cord does not stop power function if battery option is present and battery is charged.
8. Always completely deactivate the battery before servicing, transporting, or shipping. Refer to pg. 35 for instructions.
9. Should the battery enclosure be damaged, deformed, or have any sign of leakage, the chair and battery should be taken out of service immediately. Batteries should be disposed of appropriately. Contact your municipal hazardous waste center for instructions. Always handle leaking batteries with gloves.

IMPORTANT: PLEASE READ

For Heat & Heat and Massage Option:

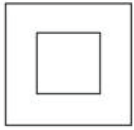

This equipment is marked with the industry recognized symbol indicating it is a “Class II Double-Insulated” device as defined by IEC 60601-1. As such, it does NOT require a three conductor power cord (i.e. one with a ground connection) for safety purposes. While the equipment can be safely operated with no ground connection, a three conductor power cord is provided to satisfy customer expectations for typical equipment configuration.

Devices qualifying as double insulated require different testing and examination procedures than “Class I Grounded” devices. If your facility requires the product to be tested, be sure to follow testing and examination procedures for “Class II Double-Insulated” devices.

ISOLATION DIAGRAM FOR HEAT & MASSAGE SYSTEM

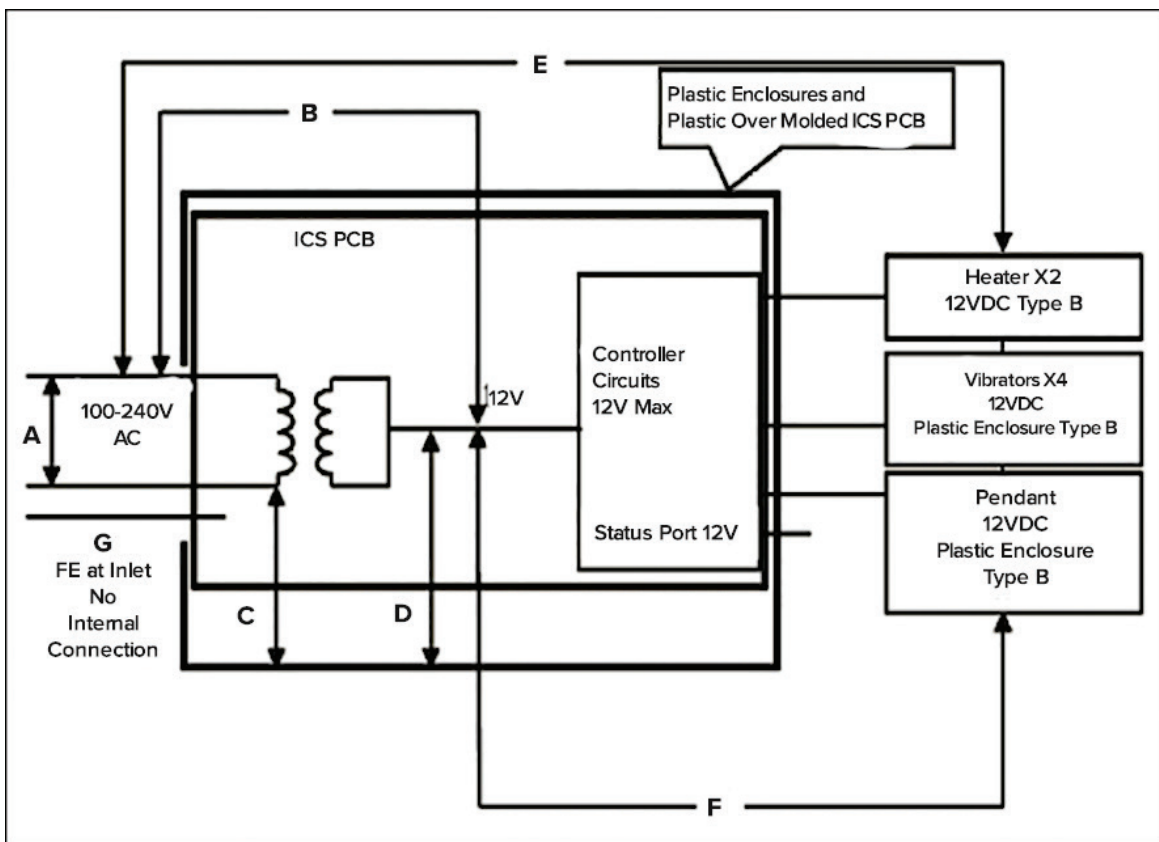

AREA	INSULATION TYPE
A	Basic Operational
B	Double Insulated / Reinforced
C	Double Insulated / Reinforced
D	Double Insulated / Reinforced
E	Double Insulated / Reinforced
F	Double Insulated / Reinforced
G	Inlet FE Pin only connects to inlet & pad

IMPORTANT: PLEASE READ

For Vero Care Cliner PRC (Power Recliner Chair) Option: Schematic Diagram

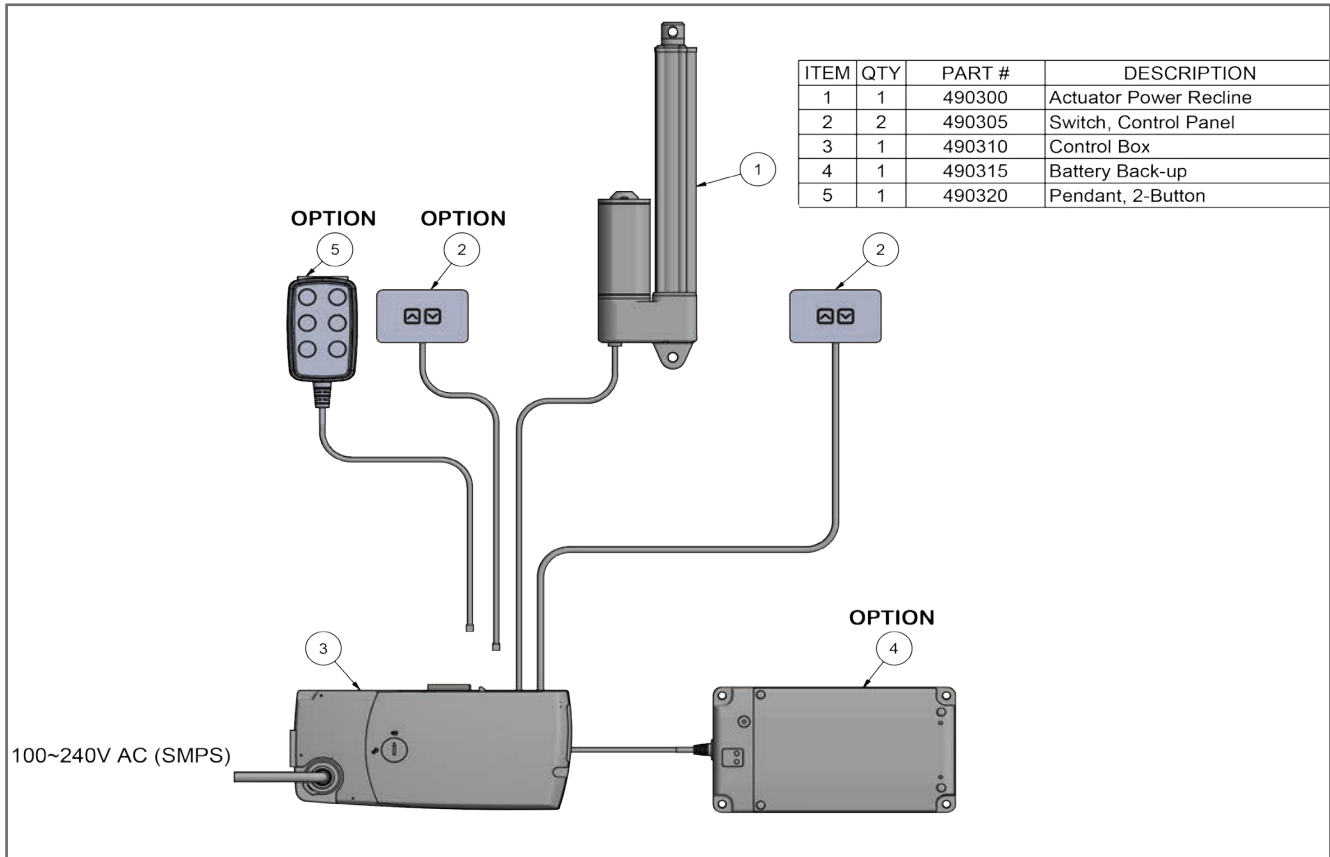

IMPORTANT: PLEASE READ

FOR ALL CONFIGURATIONS (WITH OR WITHOUT HEAT, MASSAGE, ETC.)



DO NOT LIFT OR CHANGE CHAIR RECLINE ANGLE BY USING THE LEG REST. THIS COULD CAUSE INJURY TO THE USER OR DAMAGE TO THE RECLINE MECHANISM AND WILL VOID THE WARRANTY.

1. **READ AND FOLLOW ALL DIRECTIONS.**
2. This is a clinical medical recliner. It is used to position an occupant comfortably while receiving various treatment regimens. Care should always be taken to assess an occupant's medical condition **PRIOR** to use of recliner and **PRIOR** to positioning occupant to determine if this reclining chair is medically appropriate for the occupant's use.
3. Keep all extremities clear of the recliner mechanisms when operating the chair with an occupant. Exercise caution while attending to the occupant of the chair. They have the ability to change the position of the chair unexpectedly, which can cause injury.
4. Keep children away from the extended foot support mechanism, from behind the chair, or near any moving parts.
5. **DO NOT** use the recliner if the Trendelenburg Damper and/or Gas Spring is removed or damaged.
6. **DO NOT** put hands, feet or clothing into any openings when changing positions on recliner. Attendant **MUST** confirm that user's arms, legs, hands and feet are safe while changing recliner angle or **SERIOUS INJURY MAY RESULT.**
7. Remove or move chair accessories (i.e. side table, pivot table, etc.) out of the way of occupant's legs when reclining the occupant.
8. **LOCK** casters at all times when the chair is stationary **AND** when an occupant is in the chair. **UNLOCK** casters **ONLY** when moving the chair for any reason.
9. **DO NOT** use recliner for transporting occupant in a vehicle or trailer. Winco recliners have not been tested or approved for use by an occupant in a vehicle or trailer.
10. **DO NOT** use chairs to transport patients unless properly configured with a footplate, push handle, gas back, or power recline option.
11. **NEVER** sit on the chair arms, backrest, or legrest; **SERIOUS INJURY** to user may occur. The chair may be damaged.
12. Periodically check the tightness of all nuts, bolts, and screws at least once every year.
13. Any recliner with broken recline mechanisms, torn upholstery, or other mechanical or visible damage should be immediately removed from service until repaired.
14. **NEVER EXCEED** the recommended weight capacity. Overloading a chair may cause serious damage to user. The chair may be damaged. Overloading the chair voids the warranty.
15. **USE ONLY WINCO AUTHORIZED REPLACEMENT PARTS FOR REPAIRS TO THE CHAIR.**
16. Chairs are suitable for indoor use only. Keep this product in a dry environment. Never operate the chair in wet conditions.



USE CAUTION WHEN CLEANING NEAR MECHANISMS. KEEP FINGERS, HANDS, AND ALL OTHER BODY PARTS AWAY FROM MOVING PARTS THAT CAN CAUSE SERIOUS INJURY.

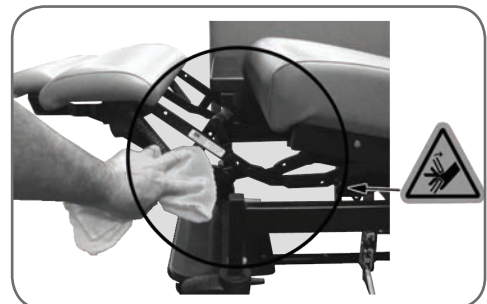

ASSEMBLY INSTRUCTIONS

BACK ASSEMBLY

1. Lock **ALL four (4)** casters on chair base with your foot (See "Lock / Unlock Casters").



Keep objects and persons clear of the chair before performing step 2.

2. Recline mechanism should be in the upright position. Remove any packaging on the mechanism.
3. Pull up the apron and rear cover on the lower rear of the back, exposing the mounting brackets (A). Lift the upholstered back by its sides while aligning the mounting brackets with the recline mechanism (B).



Keep hands clear of connection points or injury may occur.



- It is recommended that **two (2)** people be used to complete Step 3-A and 3-B.
- Be careful not to tear or puncture vinyl.

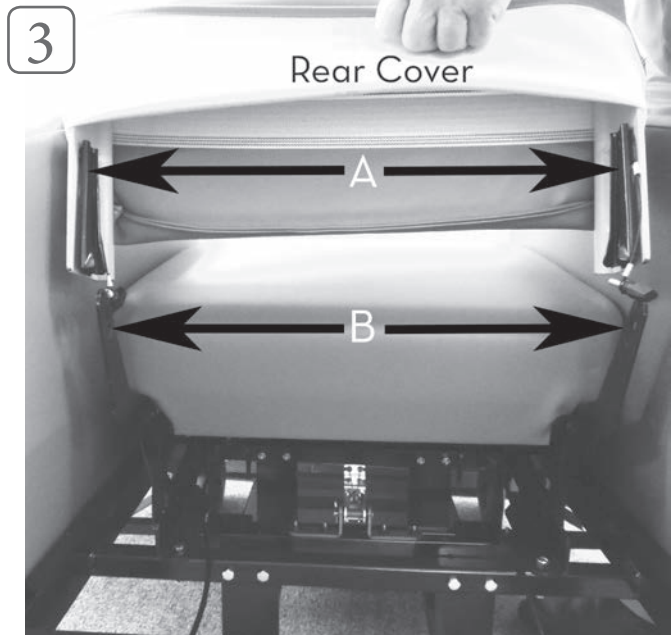

"BACK ASSEMBLY" CONTINUED ON THE NEXT PAGE.

BACK ASSEMBLY - CONTINUED

- Slide the back onto the recline mechanism until the middle hole of the mounting bracket A is aligned with the middle hole of the recline mechanism arm B **(4)**.



It is recommended that two people be used for this step.

- Install knob A (tethered to back) and tighten securely **(5)**.



Test the back installation by pulling up on the back. The back should remain securely in place. If the back is loose, check that bracket A has captured arm B and that knob is securely tightened in place **(5)**.

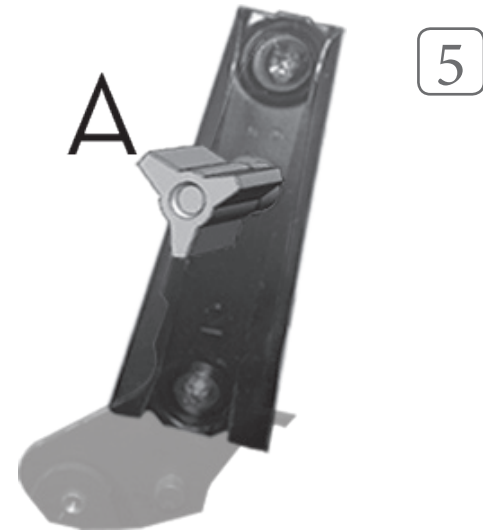
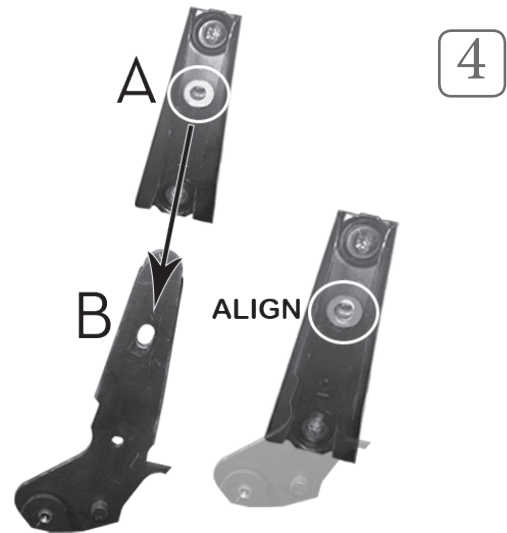

ARMREST COVER INSTALLATION (OPTIONAL ACCESSORY)

NOTE: Cover designs vary based on chair options (i.e. tables, heat/massage, etc).

CHAIRS WITH SIDE TABLES

1. Raise the side table by grasping the center of the table and gently lift into place.
2. Locate large square opening in cover and position over the side table. Gently stretch the opening over the side table and slide over side table.
3. Fit the front portion of the armrest cover over the front of the arm. Pull down tight for best fit.
4. Fit the rear portion of the armrest cover over the rear of the arm.
5. For the premium table, you will need to release the table slightly to allow space to tuck the apron into the gap. The standard table will have enough room in the upright position.
6. Pull the apron through the gap at the back of the side table completely (premium side table pictured). Smooth out wrinkles.

NOTE: Install right hand cover over right arm and left hand cover over left arm.

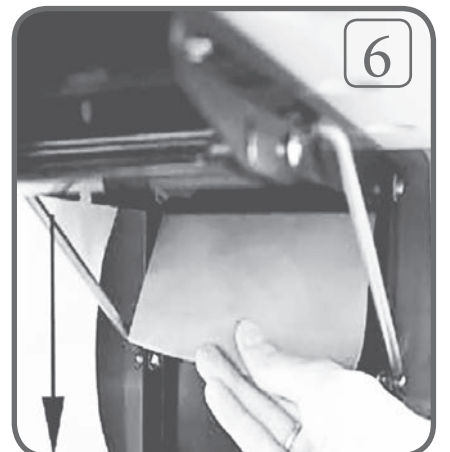
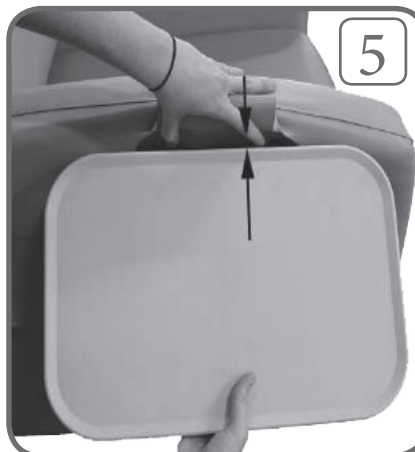
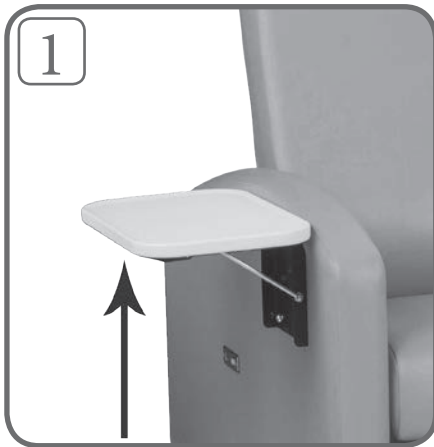

ARMREST COVER INSTALLATION - CONTINUED

CHAIRS WITH PIVOT TABLES

1. Remove the adjustment knob and the pivot table completely. You **MUST** remove the knob.
2. Pull the arm rest cover down over the chair arm. Ensure the pivot table bracket is inserted through the hole in the arm rest cover.
3. Reinstall the pivot table and adjustment knob.

NOTE: Install right hand cover over right arm and left hand cover over left arm.

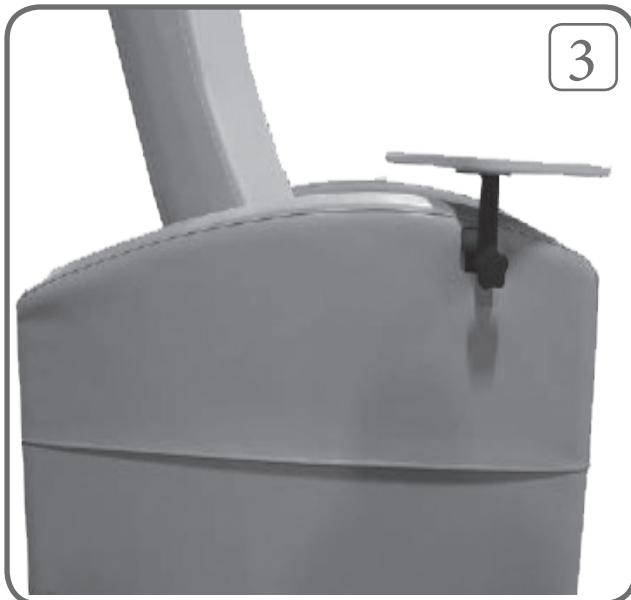
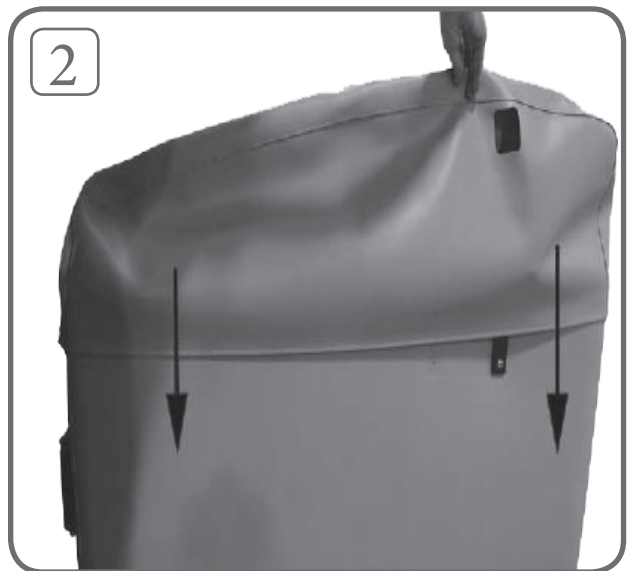
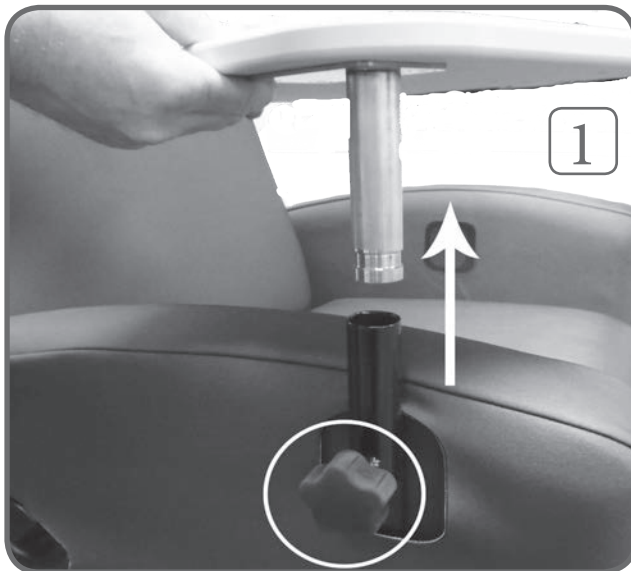

OPERATING INSTRUCTIONS: ATTENDANT

CASTER OPERATION: LOCK / UNLOCK

There are multiple caster and foot types available for this recliner, including, 5" casters with foot plate (rigid, total-lock), 3" casters without foot plate (wheel-lock), and pedestal feet. Total-lock casters lock the wheel and swivel mechanism when pressing down on the tab.

5" CASTERS: RIGID, TOTAL-LOCK

The **front two (2) casters** are rigid casters. They are **NOT** designed to swivel in order to facilitate stable straight steering. In addition, the front locking tabs are always accessible. When the locking tabs are locked down, caster wheels will **NOT** roll.

The **rear two (2) casters** are total-lock casters. They are designed to swivel 360°. When locking tab is locked down, caster wheels will **NOT** roll and caster will **NOT** swivel.

1. **TO LOCK CASTER:** Press down on the wheel tab (A) with the sole of your shoe. Tab will lock wheel into position shown.
2. **TO UNLOCK CASTER:** Press down on the **TOP** of the wheel tab (B) with the sole of your shoe. Tab will return to position shown, unlocking the wheel.

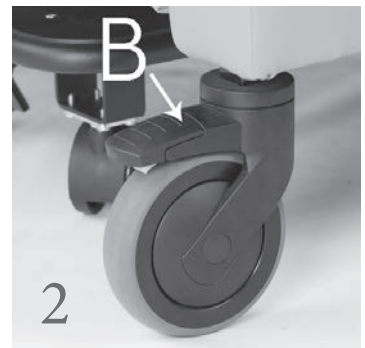
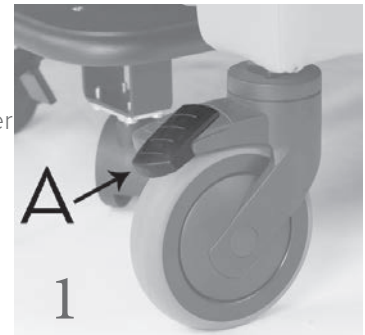

3" CASTERS



LOCK CASTERS AT ALL TIMES, EXCEPT WHEN MOVING OR TRANSPORTING THE CHAIR. ALWAYS MAKE SURE CASTER BRAKES ARE SET BEFORE AND AFTER OCCUPANT USE.

1. **TO LOCK CASTER:** Press down on the wheel tab (1) with the sole of your shoe. The tab will lock into position shown.
2. **TO UNLOCK CASTER:** Press down on the **TOP** of the wheel tab (2) with the sole of your shoe. The tab will return to the position shown, unlocking the wheel.



ALWAYS LOCK THE CASTERS WHEN THE OCCUPANT ENTERS OR EXITS THE CHAIR. UNLOCK CASTERS WHEN MOVING THE CHAIR. CHAIRS WITH 3" CASTERS ARE NOT SUITABLE FOR PATIENT TRANSPORT.

NOTE: All four (4) 3" casters are wheel-locking only. 3" casters DO NOT have TOTAL and DIRECTIONAL locking.

NOTE: Caster appearance may vary from those pictured here, but operation is the same.



CASTER OPERATION - CONTINUED

PEDESTAL FEET

Pedestal feet are designed for chairs that are intended to remain in a stationary position.



FOOT PLATE OPERATION (OPTIONAL FEATURE)



Use slide-out foot plate with qualified staff assistance only. **ONLY GAS-BACK and PRC** models equipped with a **FOOT PLATE** are suitable for occupant transport (5X08, 5X18, 5X48, 5X58, 6X08, 6X18, 6X48, 6X58, 5P, and 6P). No other models are suitable for occupant transport.



Prior to transporting an occupant, ensure that the footplate is fully extended and the chair is in a fully upright, locked position. **NEVER** transport an occupant with their feet hanging down, without the footplate in place, as this may cause serious injury.



Chairs with 3" casters OR without a footplate are **NEVER** suitable for patient transport.

NOTE: The foot plate option is **ONLY** available for models with 5" casters.



The foot plate for the Standard Verō is rated for a **MAXIMUM** weight capacity of 350 lbs (158.8 kg).



The foot plate for the XL Verō is rated for a **MAXIMUM** weight capacity of 500 lbs (226.8 kg).

1. **TO EXTEND:** Using your foot, pull out the foot plate as far as it will travel. The foot plate can now be used by the occupant.
2. **TO STORE:** Using your foot, push in on the foot plate until it is returned to the fully stored position.
 - The foot plate can be a tripping hazard if not returned to its stored position after use.
 - **ALWAYS** store the foot plate when not in use.



RECLINE CHAIR (ATTENDANT POSITION, NON POWER RECLINER MODELS ONLY)

Attendant should stand on the **RIGHT** or **LEFT** side of chair. Lock **ALL** four (4) Casters.

MANUAL ADJUSTMENT CHAIRS (Y MODELS)

1. While occupant is seated in the chair, place one hand on the arm for support and push back on the back to recline **(1)**.

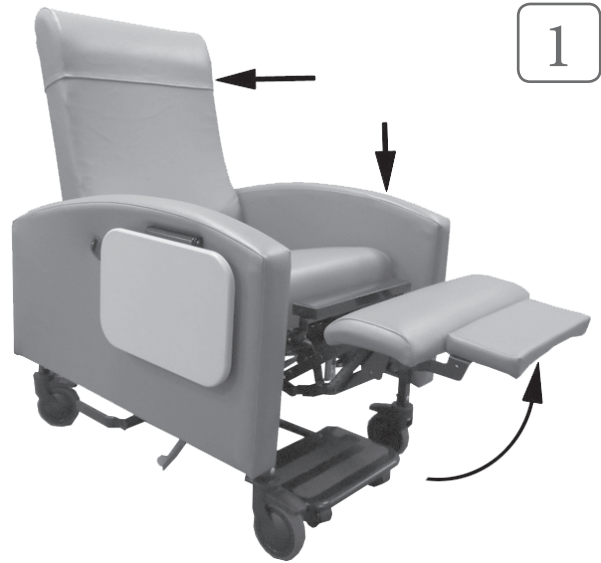

INFINITE GAS SPRING ADJUSTMENT (X MODELS)

*Models with a recline lever **(2A)**

2. To operate the infinite back recline, use one hand to operate the recline lever **(2A)** and the other hand to push on the upholstered back **(2B)** until desired recline angle or maximum recline has been reached.
3. Release recline lever **(2A)** to maintain back position.



Do **NOT** force the chair back up or down without fully extending the recline lever or damage to the chair may occur.

RETURN CHAIR TO UPRIGHT POSITION (ATTENDANT POSITION, NON POWER RECLINER MODELS ONLY)

Attendant should stand on the **RIGHT** or **LEFT** side of chair. Lock **ALL** four (4) Casters.

MANUAL ADJUSTMENT CHAIRS (Y MODELS)

1. Pull up on the back to return to upright position.
2. Attendant can use one hand to push down on the leg rest (C) until it returns to its stored position.



WARNING

Keep hands clear of mechanism to avoid injury. Use hands on face of leg rest **ONLY**.

INFINITE GAS SPRING ADJUSTMENT (X MODELS)

1. While occupant is reclined in the chair, attendant should use one hand to operate the recline lever (A), while using the other hand to pull up on the back (B).
2. Attendant can use one hand to push down on the leg rest (C) until it locks into its stored position.



WARNING

Keep hands clear of mechanism to avoid injury.

Release the recline lever (A) once the back has fully returned to the upright position.

NOTE: The recline lever is NOT required to return leg rest to its stored position.



WARNING

Attendant should **NOT** use their foot to return leg rest to its stored position. Damage to the mechanism and upholstery may occur.

1

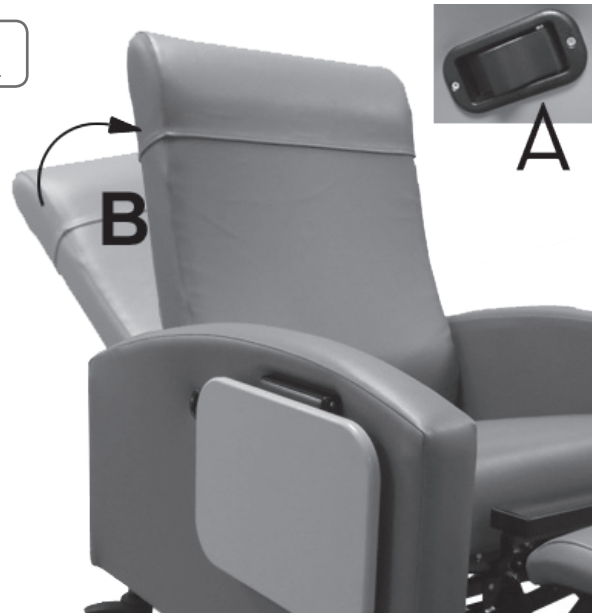

2





Trendelenburg is a medical patient positioning treatment. It should **ONLY** be used by trained personnel **AND** where indicated by occupant condition.

ACTIVATE TRENDELENBURG POSITION (ATTENDANT ONLY, NON POWER MODELS ONLY)

Attendant should stand on the **RIGHT** or **LEFT** side of chair. Lock **ALL** four (4) Casters. Before using Trendelenburg recline on the occupant, it is highly recommended that the attendant be thoroughly trained with its proper use.

1. While occupant is in the chair, place the chair into the fully reclined position (**SEE** "Recline Chair From Attendant Position").
2. Once chair is fully reclined, attendant can push down on the rear of the Trendelenburg lever (A) with their foot, allowing it to pivot down.
3. Hold the Trendelenburg lever down with your foot and push down on the chair's back (B). This will shift the occupant into the Trendelenburg position. Release Trendelenburg lever.

NOTE: The chair does **NOT** lock in the Trendelenburg position.



Chair must be in the fully reclined position **BEFORE** occupant can be placed into Trendelenburg.



DO NOT leave occupant in Trendelenburg angle unattended.

RETURN CHAIR TO RECLINE POSITION (ATTENDANT ONLY)

Attendant should be positioned on the **RIGHT** or **LEFT** side of chair.

NOTE: Pushing down on the seat (B) is recommended for maximum leverage.

1. To return chair to the recline position, push down on seat (recommended) or lift up on chair back.

NOTE: It is not necessary to press the Trendelberg lever.

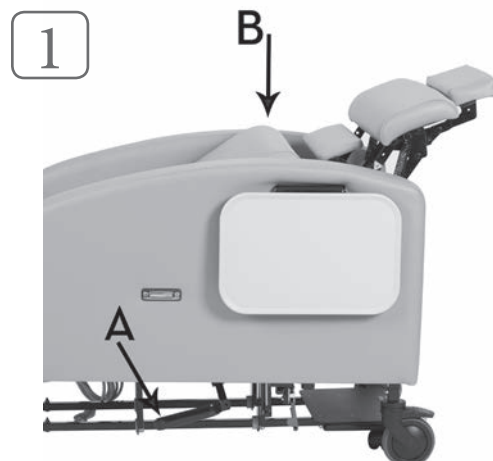

RECLINE CHAIR (ATTENDANT POSITION, VERO CARE CLINER PRC MODELS ONLY)

1. Attendant should stand on the side of the chair where the switch panel is located. Lock **ALL** four (4) Casters. Some chairs have one or two switch panels depending on model. An optional pendant is available.
2. Attendant should check for obstructions and that occupant's hands and feet are clear of the chair mechanism before operating the power recline.
3. Press the down button on the switch or pendant to lower occupant recline angle (2 or 3).
4. Do not try to push the chair back manually to adjust the recline angle.

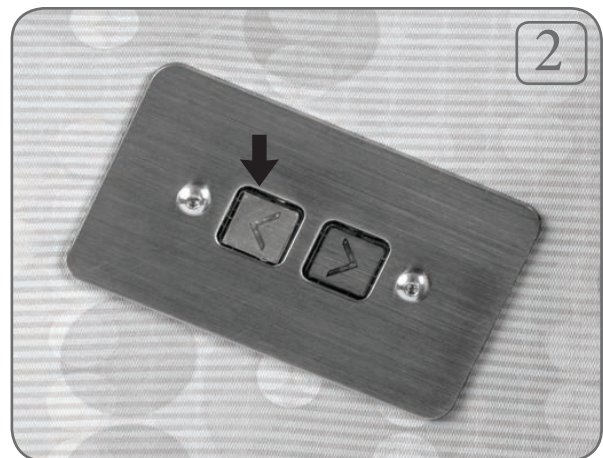

RETURN CHAIR TO UPRIGHT POSITION (ATTENDANT POSITION, VERO CARE CLINER PRC MODELS ONLY)

1. Attendant should stand on the side of the chair next to a switch panel. Lock **ALL** four (4) Casters.
2. Attendant should check for obstructions and that occupant's hands and feet are clear of the chair mechanism before operating the power button.
3. Press the up button on the switch or pendant to raise occupant recline angle (2 or 3).



ACTIVATE TRENDELENBURG POSITION
(OPTIONAL FEATURE, ATTENDANT ONLY, VERO CARE CLINER PRC MODELS ONLY)



Attendant should stand on the **side of the chair next to a switch (or use pendant) and trendelenburg lever**. Lock **ALL** four (4) Casters. Before using Trendelenburg recline on the occupant, it is highly recommended that the attendant be thoroughly trained with its proper use.

1. Attendant should remove obstructions and check occupant's hands and feet are clear of the chair mechanism before operating the power button.
2. Press the down button to lower the occupant recline angle all the way down.
3. Once chair is fully reclined, push down on the Trendelenburg lever with foot.
4. Hold the Trendelenburg lever down and push down on the chair's back. This will shift the occupant into the Trendelenburg position. Release Trendelenburg lever.



WARNING

Do not leave patient in Trendelenburg angle unattended.



WARNING

Do not leave occupant in Trendelenburg angle once medical emergency treatment is finished.

To take an occupant out of Trendelburg please refer to page 21, under "Return Chair to Recline Position (Attendant Only)".

SWING-ARM OPERATION (ATTENDANT ONLY)

Attendant should stand on the **RIGHT** or **LEFT** side of chair to open swing arms. Lock **ALL** four (4) Casters.

TO OPEN: Press down on red latch handle to unlock swing-arm.

! WARNING

- **DO NOT** leave occupant unattended when any swing-arms are unlatched.
- An occupant should **NOT** be transported with the swing-arms open. **After transferring an occupant, the swing-arm should be securely latched closed.**

TO CLOSE: Push the swing-arm firmly against the frame. The latch will automatically engage with an audible "click".

! WARNING

- Make sure the swing-arm latches are locked when the swing-arms are in the closed (latched) position. Test by pulling on arms. The arms should not swing open if properly locked.

! IMPORTANT

Swing-arms pivot out 180°. When both arms are pivoted fully back, chair width is reduced to 34.5" to transport chair through narrow doorways. The swing-arm can be pivoted back in order to get a wheel chair or gurney close to the chair.

1. Unlock both swing-arms and rotate them to the rear of the chair.
2. Stand behind the chair to maneuver the chair through the doorway.

! WARNING

- **DO NOT** recline chair with any swing-arms in the 180° position.
- Evaluate the position of the chair in comparison to other objects near it. While the arms are open, ensure that there is enough clearance between the arm and other objects, so that there is no interference with its functionality and to prevent the possibility of damage to the chair.
- Keep the chair away from other furniture and loose objects to prevent damage to the chair.
- Keep chair away from building walls, columns, and structural objects to prevent damage during recline operations.



PATIENT TRANSFERS INTO CHAIR (SWING-ARM ONLY)

Attendant should stand on the **RIGHT** or **LEFT** side of chair.



Lock all casters before occupant enters or exits the chair.

1. Lock all **four (4)** casters.
2. Move the chair back into a seated or reclined angle that matches the occupant transfer angle.
3. Unlatch one swing-arm and rotate to the 180° position at the back of the chair.
4. Position a gurney or wheel chair next to the chair on the open swing-arm side.
5. Transfer the occupant to the chair following facility safe patient handling policies.
6. Close the swing-arm and ensure the latch is locked.



- **DO NOT** leave the swing-arm open after the occupant is transferred to the chair.
- When closing the swing-arm, make sure the occupant's extremities are clear of the swing-arm.
- When closing the swing-arm, make sure any foreign objects are clear of the swing-arm and latch.



3



SIDE TABLE OPERATION (OPTIONAL FEATURE)

STANDARD SIDE TABLES

1. **TO RAISE TABLE:** Grasp the center of the table and gently raise until it locks in place, level with the floor. The table will automatically lock into place when released.
2. **TO LOWER TABLE:** Grasp the table on both sides near the arm, raise and lower down in a single movement.



PREMIUM SIDE TABLES

1. **TO RAISE TABLE:** Grasp the center of the table and gently lift until it locks in place. The side-table will lock into place with an audible "click" once fully extended.
2. **TO STORE:** Press up on the lever located under the side-table and lower to its stored position.

! WARNING

- **DO NOT** lean or sit on the side tables.
- **DO NOT** use the table for support or assistance when exiting or entering the chair.
- Keep hands and objects clear of the moving parts of the table mechanism.



Side-tables are rated for a **MAXIMUM** weight capacity of 20 lbs (9.0 kg).



PIVOT TABLE OPERATION (OPTIONAL FEATURE)

POSITION TABLE

1. Loosen the adjustment knob (A) and swing away or place in the "lap" position.
2. Tighten the adjustment knob (A) to secure position.

REMOVE TABLE

3. Loosen the adjustment knob (A) two full turns and lift up on pivot-table.



- **DO NOT** lean or sit on the pivot tables.
- **DO NOT** use the table for support or assistance when exiting or entering the chair.
- Keep hands and objects clear of the moving parts of the table mechanism.
- Make sure pivot table is clear of patient at all times, during ingress, egress, or recline.



Pivot-tables are rated for a **MAXIMUM** weight capacity of 20 lbs. (9.0 kg.)



The pivot table should be secured by knob (A) after every adjustment. The path of the pivot table should be clear whenever using the swing-arm function or positioning the patient.

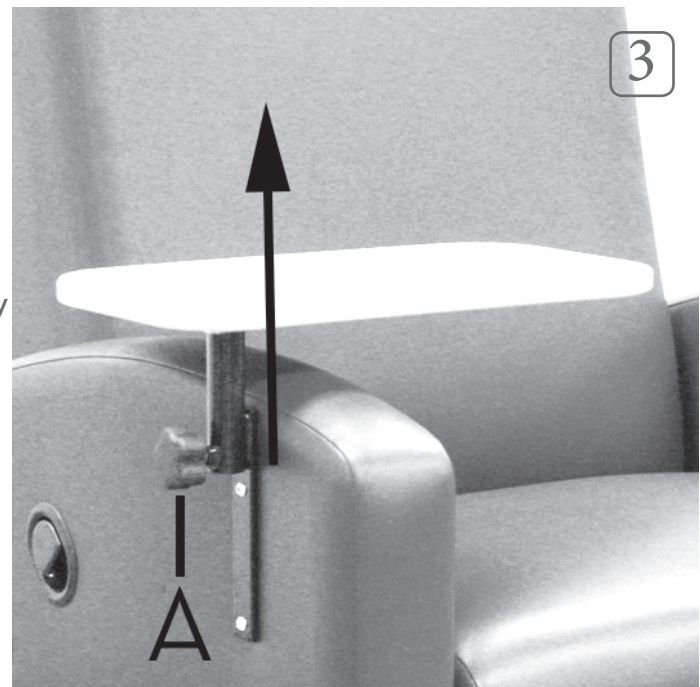

OPERATING INSTRUCTIONS: OCCUPANT

RECLINE WHILE IN THE SEATED POSITION (NON POWER RECLINER MODELS ONLY)

MANUAL ADJUSTMENT AND GAS BACK CHAIRS

1. While seated in the chair, with **ALL** four (4) casters locked, place hands on each chair arm and push back while applying pressure to the back with shoulders, to activate the mechanism into the desired position.

INFINITE GAS SPRING ADJUSTMENT

1. To operate the infinite back positioning, lock ALL four (4) casters, pull back on the recline lever and adjust the upholstered back angle by pushing back with your body until desired angle has been reached.
2. Release the recline lever (A) when you have achieved the desired angle to lock the back into position.



- **DO NOT** stand or sit on the leg rest.
- **DO NOT** place hands, legs, or feet under seat, mid-ottoman, or leg rest.
- Stay clear of recline mechanism when operating chair.

1



1



RETURNING TO SEATED POSITION (NON POWER RECLINER MODELS ONLY)

MANUAL ADJUSTMENT AND GAS BACK CHAIRS

1. To return the back (B) to the full upright position, lock **ALL** four (4) casters, grasp chair arms (A) with both hands and pull body forward.
2. Press down on the leg rest (C) with legs and feet until it is stored.



Make sure all objects, hands and feet are clear of all mechanisms before lowering leg rest.

INFINITE GAS SPRING ADJUSTMENT

For models with recline lever

3. To return the back (B) to the full upright position, pull back on either of the recline levers (D) and lean body forward. Release the recline lever once the back has fully returned to the upright position.
4. Press down on the leg rest (C) with legs and feet until it is stored.

NOTE: The recline lever does **NOT** have to be used to return the leg rest to its stored position.



Make sure all objects, hands and feet are clear of all mechanisms before lowering leg rest.

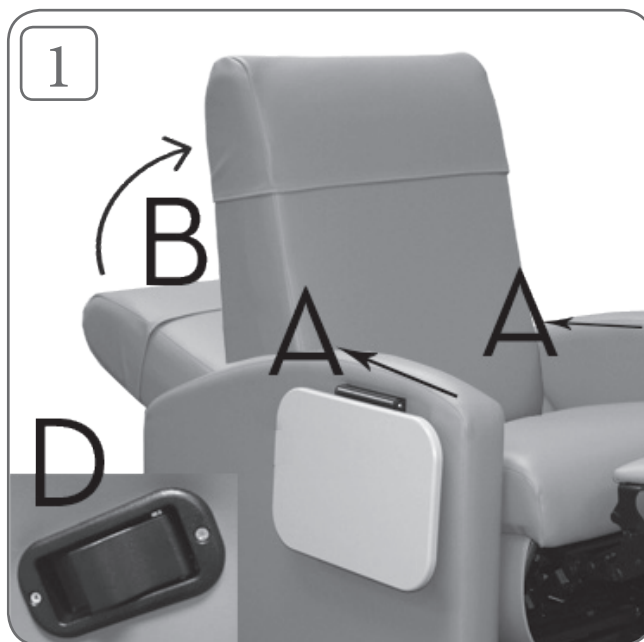

RECLINE WHILE IN THE SEATED POSITION (VERO CARE CLINER PRC MODELS ONLY)

With **ALL** four (4) casters locked, push down on the recline button until desired position is met (2 or 3).



- Do not stand or sit on leg rest.
- Do not place hands, legs, or feet under seat, mid ottoman, or leg rest.
- Stay clear of recliner mechanism when operating chair.
- Check for and remove any obstructions from recliner path prior to operating recline switch.

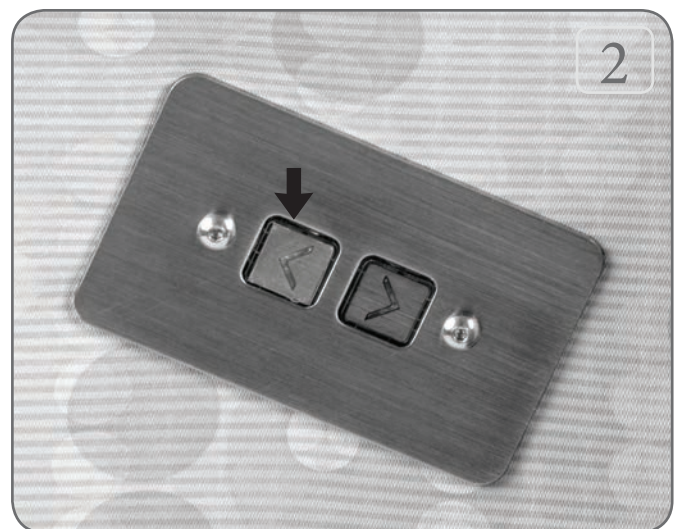

RETURNING TO SEATED POSITION (VERO CARE CLINER PRC MODELS ONLY)

With **ALL** four (4) casters locked, push down on the incline button until desired position is met (2 or 3).



- Do not stand or sit on leg rest.
- Do not place hands, legs, or feet under seat, mid ottoman, or leg rest.
- Stay clear of recliner mechanism when operating chair.
- Check for and remove any obstructions from recliner path prior to operating recline switch.



HEAT AND HEAT & MASSAGE OPERATION (OPTIONAL FEATURE)

The control panel is located on the inside of right arm of the chair (right is determined as if sitting in the chair).



**HEAT
MASSAGE**

OR



HEAT ONLY

HEAT

Heating elements are located in the seat and the seat-back of chair.

To operate, push **HEAT** button and check the indicator lights on control panel:

- 3 Lights** = High Heat / Bright Light
- 2 Lights** = Medium Heat / Medium Light
- 1 Light** = Low Heat / Dim Light
- No Light** = HEAT OFF

Allow 5-8 minutes for chair back and seat to warm to desired setting.

Heat will automatically shut off after approximately 60 minutes. The timer resets each time the switch is pressed.

MASSAGE

The massage option uses **four (4)** separate motors located in the backrest of the chair. **Two (2)** motors are located in the lower backrest, and **two (2)** are in the middle, upper backrest.

To operate, push the **MASSAGE** button the following number of times:

- 1X** = Lower Back / Low Intensity
- 2X** = Lower Back / High Intensity
- 3X** = Upper & Lower Back / Low Intensity
- 4X** = Upper & Lower Back / High Intensity
- 5X** = Alternating Upper & Lower Back
- 6X** = MASSAGE OFF

Massage will automatically shut off after approximately 15 minutes. The timer resets each time switch is pressed.

HEAT AND HEAT & MASSAGE OPERATION - CONTINUED

CLEANING:

1. Unplug power cord from outlet.
2. Clean switch, wiring, and power pack (all located under the seat frame) with a **DAMP CLOTH ONLY**.

TROUBLESHOOTING:

1. If there is no heat, massage, or flashing light on the switch, check the power cord is plugged into the wall outlet **AND** power pack unit under the chair.
2. If the switch displays a flashing light, disconnect from wall, check all accessible wire connectors under the chair for possible loose connections, then replug into the wall and test again.
3. If the system still does not work, contact Winco Customer Service at 352-854-2929.

CORD STORAGE:

For models with Heat (HT), Heat & Massage (HM), and Power Recline



1. When heat and massage will not be used, the power cord should be coiled and stored in the "Hook and Loop" fastener provided on the back of the chair.
2. When the chair is moved to another location, store the power cord.
3. To prevent cord damage or tripping, store the power cord.



GENERAL MAINTENANCE

GAS CYLINDER OPERATION

DO NOT ATTEMPT TO ADJUST CYLINDER.

The Gas Cylinder is preset during manufacturing. **DO NOT** adjust the gas cylinder without contacting Winco Customer Service.

- Cylinder adjustment will not make the chair operate easier or more smoothly.
- Do not remove the cylinder. You will **NOT** be able to be reinstall it without special tools.

GENERAL CARE & CLEANING

- Periodically inspect tightness of all screws, bolts, nuts, or other fasteners every year.
- Lubricate pivot points on the recline mechanism with a lubricant approved by your facility every year.
- If equipped, periodically position the chair back into full recline position to keep the gas cylinder lubricated.

Winco Mfg., LLC's full-line of products are durable and reliable when properly cared for.

All Winco products should be:

1. Cleaned
2. Disinfected (per facility policy)
3. Rinsed
4. Allowed to air dry

Note: Disinfecting a product is not the same as cleaning the product. Disinfectants alone will not provide adequate cleaning. They do not have grease or oil cutting properties to remove grime, hair, or skin oils. The appearance, feel, and performance of your upholstery may diminish if not cleaned properly.

CLEANING

Winco chairs should be cleaned with mild soap and water solution and a damp cloth on a regular basis. Avoid harsh detergents or chemicals that could damage the upholstery or finish of your chair. If the upholstery is disinfected with chemicals or bleach mixtures, the chair **MUST** be wiped off using only clean water on a damp cloth and then air dried. Failure to rinse upholstery with clean water can result in build-up of residue. Over time residue can dry out the upholstery and cause changes to the look and feel of the upholstery, leading to cracking. When cleaning or disinfecting the inside of a swing arm, it is important to allow the arm to air dry before closing the arm or wipe with a clean, dry cloth before closing. Moisture between the arm and the frame could cause the frame to rust.

Please refer to instruction labels or tags included with your product for complete care and cleaning instructions. Retain information on the label or tag for future use.

Additional information for cleaning products with Winco Mfg., LLC's selection of vinyls can be found on our suppliers website at: <https://spradlingvinyl.com/resource-library>.

For custom vinyl, please refer to the manufacturer's instructions.



Use caution cleaning in and around mechanisms. Keep hands clear of pinch points and metal edges or injury may occur. Disconnect power cord (chairs with HM and/ or HT, or Power Chair option) and optional rechargeable battery before cleaning this product. NEVER clean or maintain your chair while it is occupied or injury may occur. Do not allow any liquid to penetrate electrical components. NEVER use a high pressure cleaner, wash tunnel, or "hose down" method to clean this product. Liquid may cause damage to the product and void your warranty.

OPTIONAL BATTERY

The battery option works with the power recline actuator to permit continued function during a general power failure. It does not provide power to Heat and Massage functions. The battery turns ON automatically when you receive a new chair and plug in the power cord. The controller automatically recharges the battery when needed.

When the power to the facility or room circuit fails, the battery stays ON to allow recliner movement on demand. When the power cord is disconnected from the outlet, the battery stays ON. A power cord could be disconnected several days before you are aware of the situation. If Power Recline stops, check the power cord is plugged into an outlet.

The battery is located at the rear of the chair on the righthand side of the mounting plate. The battery does not require periodic service. If a chair will be stored or transported to a new location, the battery can be turned OFF by pressing and holding the OFF button for a minimum of 3 seconds to prevent discharge. The battery will last longer if kept in a charged state while the power cord is plugged into an outlet. The battery warranty is 1 year. To turn on the battery, plug in the chair power cord or press and hold the ON button 1 second. Plug in the chair for 24 hours every 6 months of inactive storage to permit the controller to restore full battery charge. This procedure enhances battery life. Battery capacity after 3 months storage is 79%. Battery capacity after 6 months storage is 58%.

The battery has a status indicator LED light near the buttons on the case.

LED Color	Condition
Green – Continuous ON	Charged over 80% capacity
Green – Dimming 1 sec/1 sec	Charging under 80% capacity
Green – Dimming 0.5 sec/4 sec	Charging above 25% capacity
Orange – Dimming 0.5 sec/4 sec	Low Battery below 25% capacity
Orange – Continuous ON	Battery Failure
No Light	Battery OFF or in Protection circuit mode with less than 20% capacity

The following list defines Protection Circuit modes that turn OFF the battery:

Protection Type	Cause	Time Period
Discharge, Over Current	Current > 7.5A	>10 Seconds
Discharge, Low Voltage	Voltage <16.0 VDC	>15 Seconds
Standby, Low Voltage	Voltage <22.5 VDC	>10 Minutes



ALWAYS REFER TO THE WEIGHT CAPACITY LABEL ON YOUR CHAIR.
IN ALL CASES THE LABELING ON THE CHAIR AT THE TIME OF DELIVERY INDICATES THE CORRECT RATING FOR YOUR CHAIR - WEIGHT RATING SHOULD NOT BE EXCEEDED.

SPECIFICATIONS

5X / 5Y / 6X / 6Y: VERO CARE CLINER



5X00 shown

SEAT HEIGHT TO FLOOR W/ PEDESTAL FEET	19.25" (48.9 CM.)
SEAT HEIGHT TO FLOOR W/ 3" CASTERS	20.5" (52.1 CM.)
SEAT HEIGHT W/ 5" CASTERS	22.75" (57.8 CM.)
SEAT HEIGHT TO FOOT PLATE (5" CASTERS ONLY)	19.5" (49.5 CM.)
SEAT WIDTH - STANDARD SIZE (ARM TO ARM)	22.5" (57.2 CM.)
SEAT WIDTH - XL SIZE (ARM TO ARM)	26.5" (67.3 CM.)
OVERALL HEIGHT W/ PEDESTAL FEET	44.75" (113.7 CM.)
OVERALL HEIGHT W/ 3" CASTERS	46" (116.8 CM.)
OVERALL HEIGHT W/ 5" CASTERS	48.25" (122.26 CM.)
OVERALL WIDTH W/OUT TABLE - NO SWING ARMS OR SWING ARMS CLOSED - STANDARD	29.5" (74.93 CM.)
OVERALL WIDTH W/OUT TABLE - NO SWING ARMS OR SWING ARMS CLOSED - XL SIZE	34" (86.36 CM.)
OVERALL WIDTH - SWING ARMS OPEN 90°	+35.75" (90.81 CM.)
OVERALL WIDTH - SWING ARMS OPEN 180°	+28.5" (72.39 CM.)
BACK HEIGHT ABOVE SEAT	29" (73.7 CM.)
SEAT DEPTH	22" (55.9 CM.)
WEIGHT - STANDARD SIZE	104 LBS. (47.2 KG.)
WEIGHT - XL SIZE	122 LBS. (55.3 KG.)
WEIGHT W/ FOOTPLATE - STANDARD SIZE	114 LBS. (51.7 KG.)
WEIGHT W/ FOOTPLATE - XL SIZE	132 LBS. (59.9 KG.)

**ALL ABOVE CHAIR WEIGHTS EXCLUDE OPTIONS

MAXIMUM WEIGHT CAPACITY - STANDARD SIZE	350 LBS. (158.8 KG.)
MAXIMUM WEIGHT CAPACITY - XL SIZE	500 LBS. (226.8 KG.)

** PATIENT WEIGHT SHOULD BE EVENLY DISTRIBUTED



ALWAYS REFER TO THE WEIGHT CAPACITY LABEL ON YOUR CHAIR.
IN ALL CASES THE LABELING ON THE CHAIR AT THE TIME OF DELIVERY INDICATES THE CORRECT RATING FOR YOUR CHAIR - WEIGHT RATING SHOULD NOT BE EXCEEDED.

SPECIFICATIONS

5P / 6P: VERO CARE CLINER PRC (POWER RECLINER CHAIR)



6P43 shown

SEAT HEIGHT TO FLOOR W/ PEDESTAL FEET	20.25" (51.4 CM.)
SEAT HEIGHT TO FLOOR W/ 3" CASTERS	20.75" (52.7 CM.)
SEAT HEIGHT W/ 5" CASTERS	23.75" (60.3 CM.)
SEAT HEIGHT TO FOOT PLATE (5" CASTERS ONLY)	20.75" (52.7 CM.)
SEAT WIDTH - STANDARD SIZE (ARM TO ARM)	22.5" (57.2 CM.)
SEAT WIDTH - XL SIZE (ARM TO ARM)	26.5" (67.3 CM.)
OVERALL HEIGHT W/ PEDESTAL FEET	44" (111.8 CM.)
OVERALL HEIGHT W/ 3" CASTERS	44.5" (113 CM.)
OVERALL HEIGHT W/ 5" CASTERS	47.5" (120.7 CM.)
OVERALL WIDTH W/OUT TABLE - NO SWING ARMS OR SWING ARMS CLOSED - STANDARD	29.5" (74.93 CM.)
OVERALL WIDTH W/OUT TABLE - NO SWING ARMS OR SWING ARMS CLOSED - XL SIZE	34" (86.36 CM.)
OVERALL WIDTH - SWING ARMS OPEN 90°	+35.75" (90.81 CM.)
OVERALL WIDTH - SWING ARMS OPEN 180°	+28.5" (72.39 CM.)
BACK HEIGHT ABOVE SEAT	28.75" (73 CM.)
SEAT DEPTH	23.5" (59.7 CM.)
WEIGHT - STANDARD SIZE	140 LBS. (63.5G.)
WEIGHT - XL SIZE	158 LBS. (71.7 KG.)
WEIGHT W/ FOOTPLATE - STANDARD SIZE	150 LBS. (68 KG.)
WEIGHT W/ FOOTPLATE - XL SIZE	168 LBS. (76.2 KG.)

**ALL ABOVE CHAIR WEIGHTS EXCLUDE OPTIONS

MAXIMUM WEIGHT CAPACITY - STANDARD SIZE	350 LBS. (158.8 KG.)
MAXIMUM WEIGHT CAPACITY - XL SIZE	500 LBS. (226.8 KG.)

** PATIENT WEIGHT SHOULD BE EVENLY DISTRIBUTED

VERO CARE CLINER OPTIONS

HEAT / HEAT & MASSAGE

HM HEAT & MASSAGE
HT HEAT ONLY
FACTORY INSTALLED ONLY



PREMIUM SIDE TABLE

AVAILABLE ON LEFT, RIGHT OR BOTH
SIDES
(WOOD FINISH OPTION ALSO
AVAILABLE)



STANDARD SIDE TABLE

AVAILABLE ON LEFT, RIGHT OR
BOTH SIDES
(WOOD FINISH OPTION ALSO
AVAILABLE)



PIVOT TABLE

AVAILABLE FOR LEFT, RIGHT, OR
BOTH SIDES



ACCESSORY HOLDER

AH ACCESSORY HOLDER
AVAILABLE FOR LEFT, RIGHT, OR
BOTH SIDES



IV POLE & ATTACHMENT

IV..... IV POLE & ATTACHMENT
AVAILABLE ON LEFT, RIGHT OR
BOTH SIDES



ARM REST COVERS

AVAILABLE FOR ALL TABLE AND ARM
CONFIGURATION OPTIONS



URETHANE ARM CAP

UB URETHANE ARM CAP



HEADREST PILLOW & COVER SET

NP .. HEADREST PILLOW & COVER
SET



WARRANTY INFORMATION

WINCO MEDICAL FURNISHINGS LIMITED WARRANTY

TERMS

Winco Mfg., LLC., warrants Winco Medical Furnishing products to be free of manufacturer's defects in material and workmanship, provided that the product is used according to normal operating conditions and proper maintenance intended by manufacturer. This warranty is available only to the original retail purchaser, is non-transferable and commences on the date of retail sale; proof of purchase required.

- **Limited One Year Complete Product Warranty:** Winco Mfg., LLC warrants the complete product for one (1) year. At Winco Mfg., LLC's sole discretion, it may repair or replace any components, including batteries, that are found to be defective during the first year after shipment from the Winco facilities. Winco Mfg., LLC, shall not be liable for any labor, or any other costs incurred as a result of or in conjunction with a warranty claim.
- **Limited Three-Year Warranty:** Winco Mfg., LLC warrants the recliner mechanisms, casters, electrical components, vinyl [from cracking or delaminating], and pressurized gas springs, for a period of three (3) years. At Winco Mfg., LLC's sole discretion, it may repair or replace components found to be defective. Winco Mfg., LLC, shall not be liable for any labor, shipping or any other costs incurred as a result of or in conjunction with a warranty claim.
- **Limited Four-Year Warranty:** For the Vero Power Recline Chair Model, Winco Mfg., LLC warrants the control box and linear actuator (motor) for a period of four (4) years. At Winco Mfg., LLC's sole discretion, it may repair or replace components found to be defective. Winco Mfg., LLC, shall not be liable for any labor, shipping or any other costs incurred as a result of or in conjunction with a warranty claim.
- **Limited Lifetime Chair Frame Warranty:** Winco Mfg., LLC warrants the steel product frames, when new, for the lifetime of the original purchaser. This limited warranty does not apply to paint, finish, or any components attached to the frame such as; upholstery, foam, casters, mechanisms or related parts that are covered under above warranties. Winco Mfg., LLC shall not be liable for any labor, shipping or any other costs incurred as a result of or in conjunction with a warranty claim.

The purchaser's exclusive remedy under this warranty shall be limited to such repair or replacement of defective components at Winco Mfg., LLC's sole discretion. For warranty service, contact the dealer that the product was originally purchased from or Winco Mfg., LLC directly.

EXCLUSIONS

There are no other warranties, conditions, representations or guarantees, express or implied, made or intended by Winco Mfg., LLC and all other warranties, conditions, representations or guarantees including any warranties, conditions, representations or guarantees under any Sale of Good Act or like legislation or statute are hereby expressly excluded. Any and all other implied warranties shall not extend beyond the duration of the express warranty. Liability for incidental or consequential damage is excluded to the extent permitted by law. Some states do not allow exclusions or limitations so the above limitations or exclusions may not apply to you. This warranty gives you specific legal rights. In addition, you may also have other rights, which vary from state to state.

GENERAL PROVISIONS

No warranty herein contained or set out shall apply when damage or repair is caused by any of the following:

1. Damage in transit.
2. Accident, alteration, abuse or misuse of product i.e., exceeding weight capacities, applying inordinate pressure to footrest and/or leg rest.
3. Fire, water damage, theft, war, riot, hostility, and/or acts of God.
4. PRC Battery 1 year only.

Examples contained in this list are not to be construed as all-inclusive.

Page has been intentionally left blank.

Page has been intentionally left blank.

Page has been intentionally left blank.

**VISIT OUR WEBSITE (WINCOMFG.COM) TO VIEW OUR FULL LINE OF
MEDICAL FURNISHINGS AND STRETCHER-CHAIRS.**

**ADDITIONAL COPIES OF THIS MANUAL AND OTHER PRODUCT DOCUMENTS ARE
AVAILABLE FOR DOWNLOAD VIA THE RESOURCES SECTION OF OUR WEBSITE.**

SPECIFICATIONS SUBJECT TO CHANGE

While we endeavor to maintain consistent products, due to conditions beyond our control, specifications are subject to change without notice. We reserve the right to add or delete products at any time and without prior notice. Always provide your product's specific serial number when ordering any replacement parts. When in doubt, contact a Winco representative (352-854-2929 or 1-800-237-3377) for further information.

Copyright © 2021 Winco Mfg., LLC



CONTACT US

To arrange a demonstration or to speak with one of our associates, please feel free to contact us at:
800-237-3377 | WincoMfg.com | 5516 SW 1st Lane, Ocala, FL 34474 | Info@WincoMfg.com